

Helical Nurlock Adjustable

AD-31000 SERIES

AD-32000 SERIES



'AD' = ADJUSTABLE

Helical Nurlock ADJUSTABLE TIP

See complete DIMENSIONAL TOLERANCES
Pages P10 thru P15.

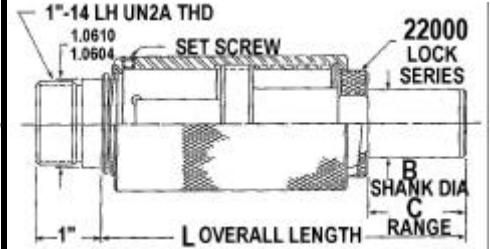
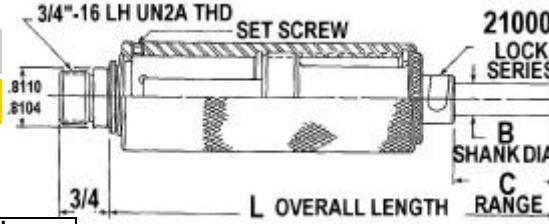

TOLERANCE ON 'A' DIMENSION	
UP TO 1/4	+ .0001 TO + .0004
OVER 1/4 TO 3/4	+ .0001 TO + .0005
OVER 3/4 TO 1-1/2	+ .0002 TO + .0006
TOLERANCE ON 'B' DIM. — .0002 TO — .0005	

← ADJUST TO REQUIRED LENGTH →

ADJUSTABLE DRILL BUSHING TIPS

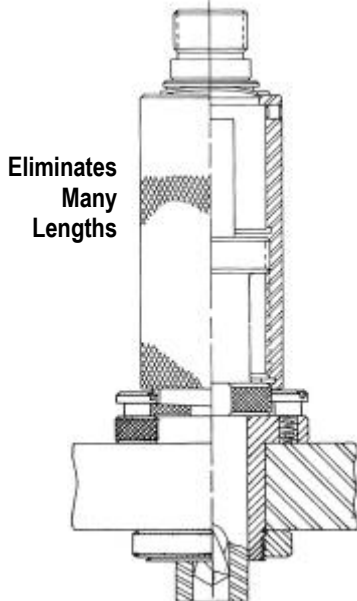

Eliminates
Many
Lengths

UNITED's Helical Nurlock Adjustable Tips are one of the most practical products developed with UNITED IMAGINEERING FEATURES:

- Reduce inventory of lengths
- Adjust to variable standoff
- Use with Standard and Nurlock liners
- Can be inserted with Press Fit Bushings for wide ID ranges

(DRILL) A	MAX	1/4	5/16	3/8	OAL	9/32	11/32	13/32	15/32	15/32	OAL			
A	MIN	3/32	3/32	3/32		3/16	3/16	3/16	3/16	3/16				
(SHANK OD) B		3/8	7/16	1/2		7/16	1/2	9/16	5/8	3/4				
C LENGTH ADJUSTS FROM		AD-31113	AD-31213	AD-31313	6-1/8	AD-32113	AD-32213	AD-32313	AD-32413	AD-32513	6-1/8			
1-1/2 to 3		AD-31125	AD-31225	AD-31325	7-5/8	AD-32125	AD-32225	AD-32325	AD-32425	AD-32525	7-5/8			
3 to 4-1/2		AD-31129-B	AD-31229-B	AD-31329-B	9-1/8	AD-32129-B	AD-32229-B	AD-32329-B	AD-32429-B	AD-32529-B	9-1/8			
4-1/2 to 6		AD-31131	AD-31231	AD-31331	10-5/8	AD-32131	AD-32231	AD-32321	AD-32431	AD-32531	10-5/8			
C LENGTH ABOVE		COLLAR AD-31000 ADD I.D. SIZE TO LINERS				COLLAR AD-32000 ADD I.D. SIZE TO LINERS								
LINER I.D.		3/8	7/16	1/2		7/16	1/2	9/16	5/8	3/4				
HELICAL NURLOCK LINERS	DOUBLE LOCK FOR METAL	HNL-213212	HNL-214808	HNL-214808		HNL-224808	HNL-224808	HNL-225210	HNL-225610	HNL-226410				
HELICAL NURLOCK LINERS	SINGLE LOCK FOR METAL	HNL-1-213212	HNL-1-214808	HNL-1-214808		HNL-1-224808	HNL-1-224808	HNL-1-225210	HNL-1-225610	HNL-1-226410				
STD NURLOCK LINERS	DOUBLE LOCK FOR METAL	NL-16520		NL-16521		WE RECOMMEND HNL and HNLP				NL-16522				
STD NURLOCK LINERS	DOUBLE LOCK FOR PLASTIC	NLP-375		NLP-500										NLP-750
LOCK SCREW LINERS	FOR METAL	LL-21100	LL-21200	LL-21300										LL-22400
LOCK SCREW LINERS	FOR PLASTIC	NL-21100	NL-21200	NL-21300		NL-22100	NL-22200	NL-22300	NL-22400					
LOCK RINGS		521449	521450A	521450A		521451	521451	521451A	521451	521452				
HELICAL NURLOCK LINERS	DOUBLE LOCK FOR PLASTIC	HNLP-213212	HNLP-214808	HNLP-214808		HNLP-224808	HNLP-224808	HNLP-225210	HNLP-225610	HNLP-226410				
HELICAL NURLOCK LINERS	SINGLE LOCK FOR PLASTIC	HNLP-1-213212	HNLP-1-214808	HNLP-1-214808		HNLP-1-224808	HNLP-1-224808	HNLP-1-225210	HNLP-1-225610	HNLP-1-226410				
TAPERED NURLOCK CLAMPS		TLC-2	TLC-2	TLC-2		TLC-2	TLC-2	TLC-2	TLC-2	TLC-2				
LINER BUSHINGS		19936	19937	19938		19937	19938	19939	19940	19941				
LOCK SCREWS		16531	16531	16531		16532	16532	16532	16532	16532				

LOCKING ACCESSORIES in this Section



Helical Nurlock Exit End Coolant

See complete DIMENSIONAL TOLERANCES
Pages P10 thru P15.

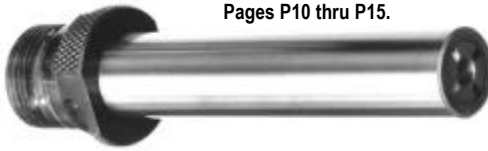

Helical Nurlock EXIT END Coolant Adapter Tip

TOLERANCE ON 'A' DIMENSION	
UP TO 1/4	+0.001 TO +0.004
OVER 1/4 TO 3/4	+0.001 TO +0.005
OVER 3/4 TO 1-1/2	+0.002 TO +0.006
TOLERANCE ON 'B' DIM. —.0002 TO —.0005	

EXIT END COOLANT DRILL BUSHING TIPS

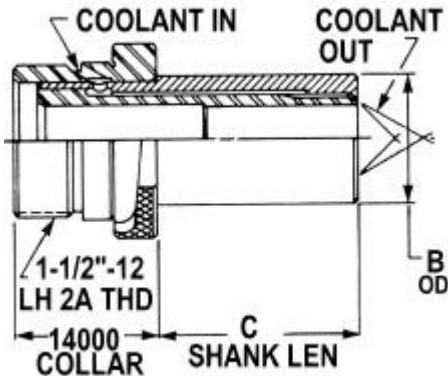

ALL COOLANT IS CONCENTRATED AT EXIT END ON HOTTEST PART OF DRILL.

COLLAR DIMENSIONS ARE THE SAME AS 21000 THRU 25000 SERIES SHOWN ON PREVIOUS (2) PAGES IN THIS SECTION. LEFT SIDE OF 21000 PAGE SHOWS STYLES AVAILABLE FOR EXIT END COOLANT, WITH THE EXCEPTION OF CONTOUR SURFACES TIPS.

UNITED IMAGINEERING

EXIT END COOLANT FEATURES:

Directs coolant thru the shank, flooding the hottest and most vulnerable portion of the cutting tool as it exits the shank and enters the work piece.

Normal cutting tool life is increased many times.

LOCKING ACCESSORIES in this Section



A-41000 SERIES

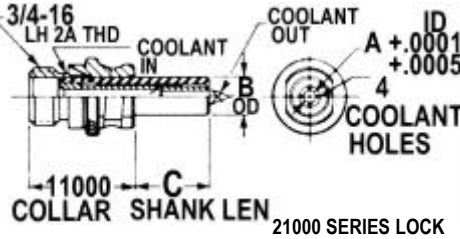

A-42000 SERIES

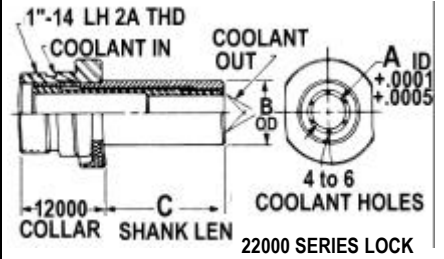

(DRILL) A	MAX	5/32	7/32	9/32	7/32	9/32	11/32	23/64	23/64
A	MIN	3/32	3/32	3/32	3/16	3/16	3/16	3/16	3/16
(SHANK OD) B		3/8	7/16	1/2	7/16	1/2	9/16	5/8	3/4
C	3/8	A-41101	A-41201	A-41301	A-42101	A-42201	A-42301	A-42401	A-42501
	1/2	A-41102	A-41202	A-41302	A-42102	A-42202	A-42302	A-42402	A-42502
L	5/8	A-41103	A-41203	A-41303	A-42103	A-42203	A-42303	A-42403	A-42503
E	3/4	A-41104	A-41204	A-41304	A-42104	A-42204	A-42304	A-42404	A-42504
N	7/8	A-41105	A-41205	A-41305	A-42105	A-42205	A-42305	A-42405	A-42505
G	1	A-41106	A-41206	A-41306	A-42106	A-42206	A-42306	A-42406	A-42506
T	1-1/16	A-41107	A-41207	A-41307	A-42107	A-42207	A-42307	A-42407	A-42507
H	1-1/8	A-41108	A-41208	A-41308	A-42108	A-42208	A-42308	A-42408	A-42508
	1-3/16	A-41109	A-41209	A-41309	A-42109	A-42209	A-42309	A-42409	A-42509
F	1-1/4	A-41110	A-41210	A-41310	A-42110	A-42210	A-42310	A-42410	A-42510
R	1-3/8	A-41111	A-41211	A-41311	A-42111	A-42211	A-42311	A-42411	A-42511
O	1-7/16	A-41112	A-41212	A-41312	A-42112	A-42212	A-42312	A-42412	A-42512
M	1-1/2	A-41113	A-41213	A-41313	A-42113	A-42213	A-42313	A-42413	A-42513
	1-5/8	A-41114	A-41214	A-41314	A-42114	A-42214	A-42314	A-42414	A-42514
C	1-3/4	A-41115	A-41215	A-41315	A-42115	A-42215	A-42315	A-42415	A-42515
O	1-7/8	A-41116	A-41216	A-41316	A-42116	A-42216	A-42316	A-42416	A-42516
L	1-15/16	A-41117	A-41217	A-41317	A-42117	A-42217	A-42317	A-42417	A-42517
L	2	A-41118	A-41218	A-41318	A-42118	A-42218	A-42318	A-42418	A-42518
A	2-1/8	STYLES AVAILABLE ALSO INCLUDE CHIP SLOT CHIP CUTTER EASE IN RADIUS CARBIDE ULTRA III Ref: Left side this page.			A-42119	A-42219	A-42319	A-42419	A-42519
R	2-1/4				A-42120	A-42220	A-42320	A-42420	A-42520
	2-3/8				A-42121	A-42221	A-42321	A-42421	A-42521
I	2-1/2				A-42122	A-42222	A-42322	A-42422	A-42522
N	2-5/8	A-42123	A-42223	A-42323	A-42423	A-42523			
	2-3/4	A-42124	A-42224	A-42324	A-42424	A-42524			
I	3	A-42125	A-42225	A-42325	A-42425	A-42525			
N	3-1/4	ORDERING INFORMATION UDB - A - 41 3 01 <ul style="list-style-type: none"> ↑ SPECIFY ID, ADDING HI-SPEED CLEARANCE REQUIRED AS 4 PLACE DECIMAL ↑ GIVE LAST TWO No.s CORRESPONDING TO 'C' ↑ SHANK OD CORRESPONDING TO 'B' ↑ LOCKING SERIES COLLAR ↑ 'A' MEANS ADAPTER SUPPLIED WITH COLLAR 							
C	3-1/2								
H	3-3/4								
E	4								
S	5								
	6								
C LENGTH ABOVE		COLLAR A-41000 ADD I.D. SIZE TO LINERS			COLLAR A-42000 ADD I.D. SIZE TO LINERS				
LINER I.D.		3/8	7/16	1/2	7/16	1/2	9/16	5/8	3/4
HELICAL NURLOCK LINERS	DOUBLE LOCK FOR METAL	HNL-213212	HNL-214808	HNL-214808	HNL-224808	HNL-224808	HNL-225210	HNL-225610	HNL-226410
HELICAL NURLOCK LINERS	SINGLE LOCK FOR METAL	HNL-1-213212	HNL-1-214808	HNL-1-214808	HNL-1-224808	HNL-1-224808	HNL-1-225210	HNL-1-225610	HNL-1-226410
STD NURLOCK LINERS	DOUBLE LOCK FOR METAL	NL-16520		NL-16521	WE RECOMMEND			NL-16522	
STD NURLOCK LINERS	DOUBLE LOCK FOR PLASTIC	NLP-375		NLP-500	HNL and HNL P				NLP-750
LOCK SCREW LINERS	FOR METAL	LL-21100	LL-21200	LL-21300			LL-22400		
LOCK SCREW LINERS	FOR PLASTIC	NL-21100	NL-21200	NL-21300	NL-22100	NL-	NL-22300	NL-22400	
LOCK RINGS		UDB-521449	UDB-521450A	UDB-521450A	UDB-521451	UDB-521451	UDB-521451A	UDB-521451	UDB-521452
HELICAL NURLOCK LINERS	DOUBLE LOCK FOR PLASTIC	HNL P-213212	HNL P-214808	HNL P-214808	HNL P-224808	HNL P-224808	HNL P-225210	HNL P-225610	HNL P-226410
HELICAL NURLOCK LINERS	SINGLE LOCK FOR PLASTIC	HNL P-1-213212	HNL P-1-214808	HNL P-1-214808	HNL P-1-224808	HNL P-1-224808	HNL P-1-225210	HNL P-1-225610	HNL P-1-226410
TAPERED NURLOCK CLAMPS		TLC-2	TLC-2	TLC-2	TLC-2	TLC-2	TLC-2	TLC-2	TLC-2
LINER BUSHINGS		19936	19937	19938	19937	19938	19939	19940	19941
LOCK SCREWS		16531	16531	16531	16532	16532	16532	16532	16532

Shanks and Accessories Exit End Coolant Series

A-43000 SERIES

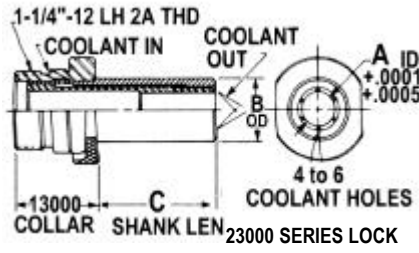

A-44000 SERIES

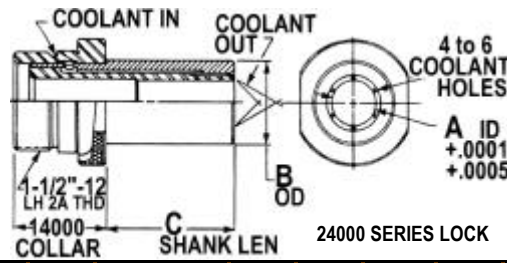

A-45000 SERIES

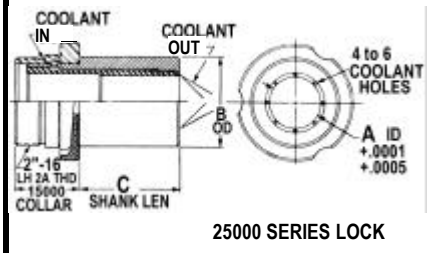

A-43000 SERIES						A-44000 SERIES										A-45000 SERIES						A MAX
15/32	1/2	9/16	5/8	21/32	21/32	3/8	1/2	19/32	5/8	3/4	7/8	7/8	7/8	7/8	7/8	53/64	61/64	1-5/64	1-21/64	1-11/16	A	
1/4	1/4	1/4	1/4	1/4	1/4	5/16	5/16	5/16	5/16	5/16	5/16	5/16	5/16	5/16	5/16	3/8	3/8	3/8	3/8	3/8	B	
NEW O.D. BELOW	3/4	13/16	7/8	1	1-1/8	5/8	3/4	13/16	7/8	1	1-1/8	1-1/4	1-3/8	1-1/2	NEW O.D. BELOW	1-1/4	1-3/8	1-1/2	1-3/4	2	3/8	
																					1/2	
																					5/8	
A-43004	A-43104	A-43204	A-43304	A-43404	A-43504	A-44104	A-44304	A-44204	A-44404	A-44504	A-44604	A-44704	A-44904	A-44804							3/4	
A-43005	A-43105	A-43205	A-43305	A-43405	A-43505	A-44105	A-44305	A-44205	A-44405	A-44505	A-44605	A-44705	A-44905	A-44805							7/8	
A-43006	A-43106	A-43206	A-43306	A-43406	A-43506	A-44106	A-44306	A-44206	A-44406	A-44506	A-44606	A-44706	A-44906	A-44806	A-45106	A-45206	A-45306	A-45406	A-45506	A-45606	1	
A-43007	A-43107	A-43207	A-43307	A-43407	A-43507	A-44107	A-44307	A-44207	A-44407	A-44507	A-44607	A-44707	A-44907	A-44807	A-45107	A-45207	A-45307	A-45407	A-45507	A-45607	1-1/16	
A-43008	A-43108	A-43208	A-43308	A-43408	A-43508	A-44108	A-44308	A-44208	A-44408	A-44508	A-44608	A-44708	A-44908	A-44808	A-45108	A-45208	A-45308	A-45408	A-45508	A-45608	1-1/8	
A-43009	A-43109	A-43209	A-43309	A-43409	A-43509	A-44109	A-44309	A-44209	A-44409	A-44509	A-44609	A-44709	A-44909	A-44809	A-45109	A-45209	A-45309	A-45409	A-45509	A-45609	1-3/16	
A-43010	A-43110	A-43210	A-43310	A-43410	A-43510	A-44110	A-44310	A-44210	A-44410	A-44510	A-44610	A-44710	A-44910	A-44810	A-45110	A-45210	A-45310	A-45410	A-45510	A-45610	1-1/4	
A-43011	A-43111	A-43211	A-43311	A-43411	A-43511	A-44111	A-44311	A-44211	A-44411	A-44511	A-44611	A-44711	A-44911	A-44811	A-45111	A-45211	A-45311	A-45411	A-45511	A-45611	1-3/8	
A-43012	A-43112	A-43212	A-43312	A-43412	A-43512	A-44112	A-44312	A-44212	A-44412	A-44512	A-44612	A-44712	A-44912	A-44812	A-45112	A-45212	A-45312	A-45412	A-45512	A-45612	1-7/16	
A-43013	A-43113	A-43213	A-43313	A-43413	A-43513	A-44113	A-44313	A-44213	A-44413	A-44513	A-44613	A-44713	A-44913	A-44813	A-45113	A-45213	A-45313	A-45413	A-45513	A-45613	1-1/2	
A-43014	A-43114	A-43214	A-43314	A-43414	A-43514	A-44114	A-44314	A-44214	A-44414	A-44514	A-44614	A-44714	A-44914	A-44814	A-45114	A-45214	A-45314	A-45414	A-45514	A-45614	1-5/8	
A-43015	A-43115	A-43215	A-43315	A-43415	A-43515	A-44115	A-44315	A-44215	A-44415	A-44515	A-44615	A-44715	A-44915	A-44815	A-45115	A-45215	A-45315	A-45415	A-45515	A-45615	1-3/4	
A-43016	A-43116	A-43216	A-43316	A-43416	A-43516	A-44116	A-44316	A-44216	A-44416	A-44516	A-44616	A-44716	A-44916	A-44816	A-45116	A-45216	A-45316	A-45416	A-45516	A-45616	1-7/8	
A-43017	A-43117	A-43217	A-43317	A-43417	A-43517	A-44117	A-44317	A-44217	A-44417	A-44517	A-44617	A-44717	A-44917	A-44817	A-45117	A-45217	A-45317	A-45417	A-45517	A-45617	1-15/16	
A-43018	A-43118	A-43218	A-43318	A-43418	A-43518	A-44118	A-44318	A-44218	A-44418	A-44518	A-44618	A-44718	A-44918	A-44818	A-45118	A-45218	A-45318	A-45418	A-45518	A-45618	2	
A-43019	A-43119	A-43219	A-43319	A-43419	A-43519	A-44119	A-44319	A-44219	A-44419	A-44519	A-44619	A-44719	A-44919	A-44819	A-45119	A-45219	A-45319	A-45419	A-45519	A-45619	2-1/8	
A-43020	A-43120	A-43220	A-43320	A-43420	A-43520	A-44120	A-44320	A-44220	A-44420	A-44520	A-44620	A-44720	A-44920	A-44820	A-45120	A-45220	A-45320	A-45420	A-45520	A-45620	2-1/4	
A-43021	A-43121	A-43221	A-43321	A-43421	A-43521	A-44121	A-44321	A-44221	A-44421	A-44521	A-44621	A-44721	A-44921	A-44821	A-45121	A-45221	A-45321	A-45421	A-45521	A-45621	2-3/8	
A-43022	A-43122	A-43222	A-43322	A-43422	A-43522	A-44122	A-44322	A-44222	A-44422	A-44522	A-44622	A-44722	A-44922	A-44822	A-45122	A-45222	A-45322	A-45422	A-45522	A-45622	2-1/2	
A-43023	A-43123	A-43223	A-43323	A-43423	A-43523	A-44123	A-44323	A-44223	A-44423	A-44523	A-44623	A-44723	A-44923	A-44823	A-45123	A-45223	A-45323	A-45423	A-45523	A-45623	2-5/8	
A-43024	A-43124	A-43224	A-43324	A-43424	A-43524	A-44124	A-44324	A-44224	A-44424	A-44524	A-44624	A-44724	A-44924	A-44824	A-45124	A-45224	A-45324	A-45424	A-45524	A-45624	2-3/4	
A-43025	A-43125	A-43225	A-43325	A-43425	A-43525	A-44125	A-44325	A-44225	A-44425	A-44525	A-44625	A-44725	A-44925	A-44825	A-45125	A-45225	A-45325	A-45425	A-45525	A-45625	3	
A-43026	A-43126	A-43226	A-43326	A-43426	A-43526	A-44126	A-44326	A-44226	A-44426	A-44526	A-44626	A-44726	A-44926	A-44826	A-45126	A-45226	A-45326	A-45426	A-45526	A-45626	3-1/4	
A-43027	A-43127	A-43227	A-43327	A-43427	A-43527	A-44127	A-44327	A-44227	A-44427	A-44527	A-44627	A-44727	A-44927	A-44827	A-45127	A-45227	A-45327	A-45427	A-45527	A-45627	3-1/2	
A-43028	A-43128	A-43228	A-43328	A-43428	A-43528	A-44128	A-44328	A-44228	A-44428	A-44528	A-44628	A-44728	A-44928	A-44828	A-45128	A-45228	A-45328	A-45428	A-45528	A-45628	3-3/4	
A-43029	A-43129	A-43229	A-43329	A-43429	A-43529	A-44129	A-44329	A-44229	A-44429	A-44529	A-44629	A-44729	A-44929	A-44829	A-45129	A-45229	A-45329	A-45429	A-45529	A-45629	4	
						A-44130	A-44330	A-44230	A-44430	A-44530	A-44630	A-44730	A-44930	A-44830	A-45130	A-45230	A-45330	A-45430	A-45530	A-45630	5	
						A-44131	A-44331	A-44231	A-44431	A-44531	A-44631	A-44731	A-44931	A-44831	A-45131	A-45231	A-45331	A-45431	A-45531	A-45631	6	
COLLAR A-43000 ADD I.D. SIZE TO LINERS						COLLAR A-44000 ADD I.D. SIZE TO LINERS										COLLAR A-45000 ADD I.D. SIZE TO LINERS						C LEN ABOVE
5/8	3/4	13/16	7/8	1	1-1/8	5/8	3/4	13/16	7/8	1	1-1/8	1-1/4	1-3/8	1-1/2	1-1/4	1-3/8	1-1/2	1-3/4	2	LINER I.D.		
HNL-235610	HNL-236410	HNL-236410	HNL-238016	HNL-239616	HNL-239624	HNL-245616	HNL-246416	HNL-246416	HNL-248016	HNL-248016	HNL-248816	HNL-249616	HNL-2411216	HNL-2412816	HNL-25100	HNL-25200	HNL-25300	HNL-25400	HNL-25500	HELICAL NUR LOCK LINERS		
HNL-1-2365610	HNL-1-236410	HNL-1-236410	HNL-1-238016	HNL-1-239616	HNL-1-239624	HNL-1-245616	HNL-1-246416	HNL-1-246416	HNL-1-248016	HNL-1-248016	HNL-1-248816	HNL-1-249616	HNL-1-2411216	HNL-1-2412816	WE RECOMMEND					HELICAL NUR LOCK SINGLE LINERS		
			NL-16523	NL-16524							NL-16525			NL-16526	HNL and HNLP					NL-16533		
			NLP-16523	NLP-16524							NL P-16525			NL P-16526						NL P-16533		
LL-23100	LL-23200	LL-23300	LL-23400	LL-23500		LL-24100	LL-24300	LL-24300	LL-24400	LL-24500	LL-24600	LL-24700		LL-24800	LL-25100	LL-25200	LL-25300	LL-25400	LL-25500	LOCK LINERS		
NL-23100	NL-23200	NL-23300	NL-23400	NL-23500		NL-24100	NL-24300	NL-24300	NL-24400	NL-24500	NL-24600	NL-24700		NL-24800	LLP-25100	LLP-25200	LLP-25300	LLP-25400	LLP-25500	LOCK LINERS		
UDB-521453A	UDB-521452	UDB-521452	UDB-521453	UDB-521454B	UDB-521454A	UDB-521451	UDB-521452	UDB-521452	UDB-521453	UDB-521453	UDB-521454A	UDB-521454B	UDB-521456A	UDB-521457A	UDB-521458A	UDB-521458A	UDB-521458A	UDB-521458A	UDB-521458A	LOCK RINGS		
HNLP-235610	HNLP-236410	HNLP-236410	HNLP-238016	HNLP-239616	HNLP-239624	HNLP-245616	HNLP-246416	HNLP-246416	HNLP-248016	HNLP-248016	HNLP-248816	HNLP-249616	HNLP-2411216	HNLP-2412816	HNLP-25100	HNLP-25200	HNLP-25300	HNLP-25400	HNLP-25500	HELICAL NUR LOCK DOUBLE LINERS		
HNLP-1-235610	HNLP-1-236410	HNLP-1-236410	HNLP-1-238016	HNLP-1-239616	HNLP-1-239624	HNLP-1-245616	HNLP-1-246416	HNLP-1-246416	HNLP-1-248016	HNLP-1-248016	HNLP-1-248816	HNLP-1-249616	HNLP-1-2411216	HNLP-1-2412816						HELICAL NUR LOCK SINGLE LINERS		
TLC-2	TLC-2	TLC-2	TLC-2	TLC-2	TLC-2	TLC-2	TLC-2	TLC-2	TLC-2	TLC-2	TLC-2	TLC-2	TLC-2	TLC-2	TLC-3	TLC-3	TLC-3	TLC-3	TLC-3	FLARED CLAMPS		
19940	19942	19943	19944	19945	19946	19940	19942	19943	19944	19945	19946	19952	19954	19955	19952	19954	19955	19956	19957	19957	LINER BUSHINGS	
16532	16532	16532	16532	16532	16532	16532	16532	16532	16532	16532	16532	16532	16532	16532	16530	16530	16530	16530	16530	16530	LOCK SCREWS	

Nurlock Telescoping Bushing Tips

See complete DIMENSIONAL TOLERANCES
Pages P10 thru P15.

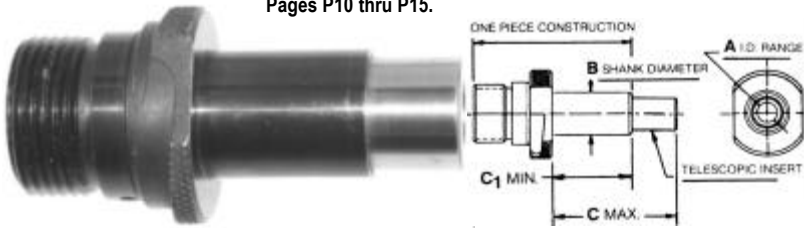

TELESCOPING COLLAR AND SHANK 50,000 SERIES

The 51000 thru 55000 Telescopic Nurlock Series is designed for use with new fixtures.

This series has closer tolerances. The one piece collar and shank construction provides superior support and precision guidance.

Fewer lengths are required thus inventory reduced.

Each insert has 1/8" minimum pre-load — 1/8" extension beyond charted 'C' maximum length.

Closer I.D. tolerances are available on request.

Shank ends are precision ground square to O.D. and I.D. to insure flush contact with workpiece.

Used for extremely close tolerance holes, using coolant air fluid chucks and spindles.

Specify UNITED's vacuum nosepieces, air-fluid chucks and reducers to insure your finished hole tolerances.

Designed to fit any conventional nosepiece for positive feed motors, Quackenbush, Zephyr, Aro, Gardner-Denver, Dotco, Spacematic, etc.

Portable high speed drilling at its very best!

ORDERING INFORMATION: Specify the Part No. required. Include Part Description and Drill Size (4 place decimal).

For Collar Only, omit prefix 'A' and add 'C.'

For Insert Only, omit prefix 'A' and add suffix 'I' plus 4 place decimal I.D. size. Example: UDB-52731-I (.2500)

For Spring Only, add suffix 'S.' Example: UDB-52731-S

UDB - A - 52731 (.2500)

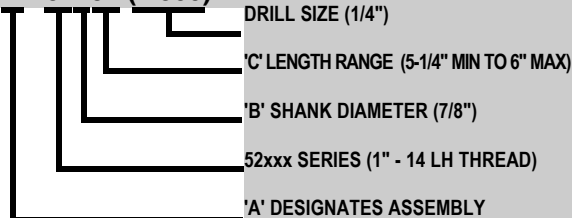

LOCKING ACCESSORIES In this Section



A-51000 3/4"-16 LH THD

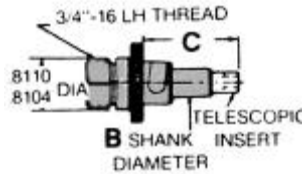
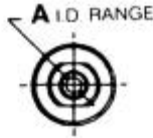

A-52000 1"-14 LH THD

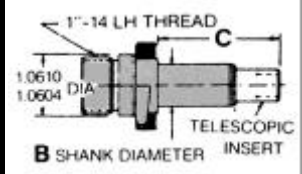
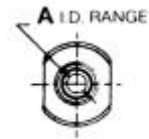

A	MAX	.136	.187	.234	.316	.375	.421	.421	
DRILL SIZE	MIN	.093	.093	.093	.187	.187	.187	.187	
B	SHANK O.D.	3/8	7/16	1/2	5/8	3/4	13/16	7/8	
C1 MIN	C MAX	A51106	A51206	A51306	A52406	A52506	A52606	A52706	
5/8	1"	A51113	A51213	A51313	A52413	A52513	A52613	A52713	
7/8	1-1/2"	A51118	A51218	A51318	A52418	A52518	A52618	A52718	
1-3/8	2"	A51122	A51222	A51322	A52422	A52522	A52622	A52722	
1-7/8	2-1/2"	A51125	A51225	A51325	A52425	A52525	A52625	A52725	
2-1/4	3"	A51127	A51227	A51327	A52427	A52527	A52627	A52727	
2-3/4	3-1/2"	A51129	A51229	A51329	A52429	A52529	A52629	A52729	
3-1/4	4"	A51129B	A51229B	A51329B	A52429B	A52529B	A52629B	A52729B	
3-3/4	4-1/2"	A51130	A51230	A51330	A52430	A52530	A52630	A52730	
4-1/4	5"	A51130B	A51230B	A51330B	A52430B	A52530B	A52630B	A52730B	
4-3/4	5-1/2"	A51131	A51231	A51331	A52431	A52531	A52631	A52731	
5-1/4	6"	COLLAR A-51000 ADD I.D. SIZE TO LINERS				COLLAR A-52000 ADD I.D. SIZE TO LINERS			
C1 MIN	C MAX	COLLAR A-51000 ADD I.D. SIZE TO LINERS				COLLAR A-52000 ADD I.D. SIZE TO LINERS			
TELESCOPIC RANGE	SEE ABOVE ON LEFT	COLLAR A-51000 ADD I.D. SIZE TO LINERS				COLLAR A-52000 ADD I.D. SIZE TO LINERS			
LINER I.D.		3/8	7/16	1/2	5/8	3/4	13/16	7/8	
HELICAL NURLOCK LINERS	DOUBLE LOCK METAL	HNL-213212	HNL-214808	HNL-214808	HNL-225610	HNL-226410	HNL-226416	HNL-227216	
HELICAL NURLOCK LINERS	SINGLE LOCK METAL	HNL-1-213212	HNL-1-214808	HNL-1-214808	HNL-1-225610	HNL-1-226410	HNL-1-226416	HNL-1-227216	
STD NURLOCK LINERS	DOUBLE LOCK METAL	NL-16520		NL-16521	NL-16522				
STD NURLOCK LINERS	DOUBLE LOCK PLASTIC	NLP-375		NLP-500		NLP-750			
LOCK SCREW LINERS	FOR METAL	LL-21100	LL-21200	LL-21300	LL-22400				
LOCK SCREW LINERS	FOR PLASTIC	NL-21100	NL-21200	NL-21300	NL-22400				
LOCK RINGS		UDB-521449	UDB-521450A	UDB-521450A	UDB-521451	UDB-521452	UDB-521452	UDB-521453A	
HELICAL NURLOCK LINERS	DOUBLE LOCK PLASTIC	HNLP-213212	HNLP-214808	HNLP-214808	HNLP-225610	HNLP-226410	HNLP-226416	HNLP-227216	
HELICAL NURLOCK LINERS	SINGLE LOCK PLASTIC	HNLP-1-213212	HNLP-1-214808	HNLP-1-214808	HNLP-1-225610	HNLP-1-226410	HNLP-1-226416	HNLP-1-227216	
TAPERED NURLOCK CLAMPS		TLC-2	TLC-2	TLC-2	TLC-2	TLC-2	TLC-2	TLC-2	
LINER BUSHINGS		19936	19937	19938	19940	19941	19943	19944	
LOCK SCREWS		16531	16531	16531	16532	16532	16532	16532	

50,000 Series

Standard

50,000 Series Telescopic

A-53000 1-1/4"-12 LH THD

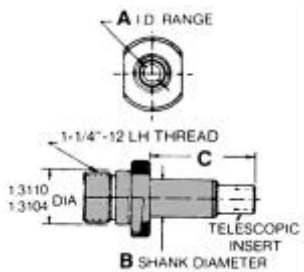

A-54000 1-1/2"-12 LH THD

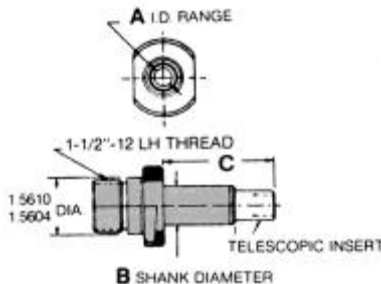

A-55000 2"-16 LH THD

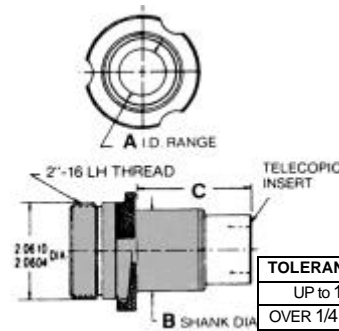

**IDEAL FOR
OIL HOLE
AND GUN
DRILLING**

TOLERANCE on 'A' DIMENSION	
UP TO 1/4	+0.001 to +0.004
OVER 1/4 to 3/4	+0.001 to +0.005
OVER 3/4 to 1-1/2	+0.002 to +0.006
TOLERANCE on 'B' DIM.	
-.0002 to -.0005	

'B' O.D. 5/8 is NEW Part No.

'B' O.D.s 13/16 and 1-3/8 are NEW Part No.s

.421	.437	.468	.500	.593	.718	.812	.531	.593	.718	.812	.906	1.062	.812	.906	1.062	1.250	1.403	1.437	MAX MIN	A DRILL SIZE							
.187	.187	.187	.187	.187	.187	.187	.312	.312	.312	.312	.312	.312	.375	.375	.375	.375	1.403	.375	.375	SHANK O.D.	B						
5/8	3/4	13/16	7/8	1"	1-1/8	1-1/4	13/16	1"	1-1/8	1-1/4	1-3/8	1-1/2	1-1/4	1-3/8	1-1/2	1-3/4	2"	2-1/4	C1 MIN 5/8	C MAX 1"							
A53006	A53106	A53206	A53306	A53406	A53506	A53606	A54206	A54506	A54606	A54706	A54906	A54806	A5510	A55206	A55306	A55406	A55506	A55606									
A53013	A53113	A53213	A53313	A53413	A53513	A53613	A54213	A54513	A54613	A54713	A54913	A54813	A5511	A55213	A55313	A55413	A55513	A55613									
A53018	A53118	A53218	A53318	A53418	A53518	A53618	A54218	A54518	A54618	A54718	A54918	A54818	A5511	A55218	A55318	A55418	A55518	A55618									
A53022	A53122	A53222	A53322	A53422	A53522	A53622	A54222	A54522	A54622	A54722	A54922	A54822	A5512	A55222	A55322	A55422	A55522	A55622									
A53025	A53125	A53225	A53325	A53425	A53525	A53625	A54225	A54525	A54625	A54725	A54925	A54825	A5512	A55225	A55325	A55425	A55525	A55625									
A53027	A53127	A53227	A53327	A53427	A53527	A53627	A54227	A54527	A54627	A54727	A54927	A54827	A55127	A55227	A55327	A55427	A55527	A55627									
A53029	A53129	A53229	A53329	A53429	A53529	A53629	A54229	A54529	A54629	A54729	A54929	A54829	A55129	A55229	A55329	A55429	A55529	A55629									
A53029B	A53129B	A53229B	A53329B	A53429B	A53529B	A53629B	A54229B	A54529B	A54629B	A54729B	A54929B	A54829B	A55129B	A55229B	A55329B	A55429B	A55529B	A55629B									
A53030	A53130	A53230	A53330	A53430	A53530	A53630	A54230	A54530	A54630	A54730	A54930	A54830	A55130	A55230	A55330	A55430	A55530	A55630									
A53030B	A53130B	A53230B	A53330B	A53430B	A53530B	A53630B	A54230B	A54530B	A54630B	A54730B	A54930B	A54830B	A55130B	A55230B	A55330B	A55430B	A55530B	A55630B									
A53031	A53131	A53231	A53331	A53431	A53531	A53631	A54231	A54531	A54631	A54731	A54931	A54831	A55131	A55231	A55331	A55431	A55531	A55631									
COLLAR A-53000 ADD I.D. SIZE TO LINERS							COLLAR A-54000 ADD I.D. SIZE TO LINERS						COLLAR A-55000 ADD I.D. SIZE TO LINERS						C1 MIN 5/8	C MAX 1"							
5/8	3/4	13/16	7/8	1"	1-1/8	1-1/4	13/16	1"	1-1/8	1-1/4	1-3/8	1-1/2	1-1/4	1-3/8	1-1/2	1-3/4	2"	2-1/4	LINER I.D.								
HNL-235610	HNL-236410	HNL-236410	HNL-238016	HNL-239616	HNL-238816	HNL-239616	HNL-248016	HNL-248016	HNL-248816	HNL-249616	HNL-2411216	HNL-2412816	HNL-25100	HNL-25200	HNL-25300	HNL-25400	HNL-25500	HNL-25600	HELICAL NURLOCK LINERS	DOUBLE LOCK FOR METAL							
HNL-1-235610	HNL-1-236410	HNL-1-236410	HNL-1-238016	HNL-1-239616	HNL-1-238816	HNL-1-239616	HNL-1-248016	HNL-1-248016	HNL-1-248816	HNL-1-249616	HNL-1-2411216	HNL-1-2412816	WE RECOMMEND HNL and HNL P						HELICAL NURLOCK LINERS	SINGLE LOCK FOR METAL							
					NL-16524				NL-16525			NL-16526													STD NURLOCK LINERS	DOUBLE LOCK METAL	
					NLP-16524				NLP-16525			NLP-16526														STD NURLOCK LINERS	DOUBLE LOCK PLASTIC
	LL-23100	LL-23200	LL-23300	LL-23400	LL-23500		LL-24500	LL-24500	LL-24600	LL-24700		LL-24800							LL-25100	LL-25200	LL-25300	LL-25400	LL-25500	LL-25600	LOCK SCREW LINERS	FOR METAL	
	NL-23100	NL-23200	NL-23300	NL-23400	NL-23500		NL-24500	NL-24500	NL-24600	NL-24700		NL-24800	LLP-25100	LLP-25200	LLP-25300	LLP-25400	LLP-25500	LLP-25600	LOCK SCREW LINERS	FOR PLASTIC							
UDB-521453A	UDB-521452	UDB-521452	UDB-521454B	UDB-521454B	UDB-521454A	UDB-521454	UDB-521453	UDB-521453	UDB-521454A	UDB-521454B	UDB-521456A	UDB-521457A	UDB-521458	UDB-521458	UDB-521458	UDB-521458	UDB-521458A	UDB-521458A		LOCK RINGS							
HNL P-235610	HNL P-236410	HNL P-236410	HNL P-238016	HNL P-239616	HNL P-238816	HNL P-239616	HNL P-248016	HNL P-248016	HNL P-248816	HNL P-249616	HNL P-2411216	HNL P-2412816	HNL P-25100	HNL P-25200	HNL P-25300	HNL P-25400	HNL P-25500	HNL P-25600	HELICAL NURLOCK LINERS	DOUBLE LOCK PLASTIC							
HNL P-1-235610	HNL P-1-236410	HNL P-1-236410	HNL P-1-238016	HNL P-1-239616	HNL P-1-238816	HNL P-1-239616	HNL P-1-248016	HNL P-1-248016	HNL P-1-248816	HNL P-1-249616	HNL P-1-2411216	HNL P-1-2412816							HELICAL NURLOCK LINERS	SINGLE LOCK PLASTIC							
TLC-2	TLC-2	TLC-2	TLC-2	TLC-2	TLC-2	TLC-2	TLC-2	TLC-2	TLC-2	TLC-2	TLC-2	TLC-2	TLC-3	TLC-3	TLC-3	TLC-3	TLC-3	TLC-3		TAPERED NURLOCK CLAMPS							
19940	19942	19943	19944	19945	19946	19952	19945	19945	19946	19952	19954	19955	19952	19954	19955	19956	19957	19958		LINER BUSHINGS							
16532	16532	16532	16532	16532	16532	16532	16532	16532	16532	16532	16532	16532	16530	16530	16530	16530	16530	16530		LOCK SCREWS							

See complete DIMENSIONAL TOLERANCES
Pages P10 thru P15.

Nurlock Telescoping Bushing Tips

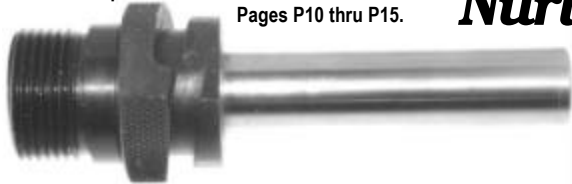

TOLERANCE ON 'A' DIMENSION	
UP TO 1/4	+ .0001 TO +.0004
OVER 1/4 TO 3/4	+ .0001 TO +.0005
OVER 3/4 TO 1-1/2	+ .0002 TO +.0006
TOLERANCE ON 'B' DIM. —.0002 TO —.0005	

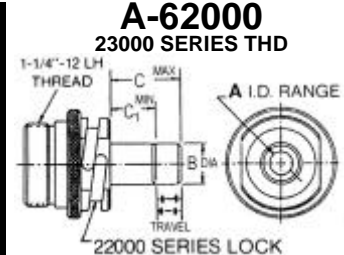
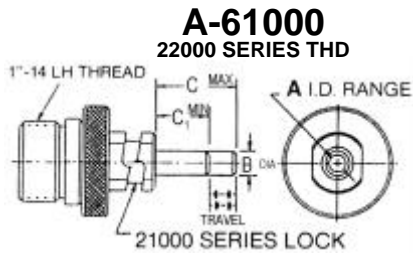

TELESCOPING COLLAR AND SHANK 60,000 SERIES

The 61000 thru 65000 Telescopic Nurlock Series is designed for use on existing fixtures.

This series used for extremely close tolerances.

Manufactured for use with coolant air fluid chucks and spindles.

Each telescopic insert has 1/8" minimum pre-load or 1/8" extension beyond charted 'C' maximum length.

Shank ends are precision ground square to O.D. and I.D. to insure flush contact with workpiece.

Specify UNITED's vacuum nosepieces, air-fluid chucks and reducers to insure your finished hole tolerances.

Designed to fit any conventional nosepiece for positive feed motors, Quackenbush, Zephyr, Aro, Gardner-Denver, Dotco, Spacematic, etc.

Portable high speed drilling at its very best!

ORDERING INFORMATION: Specify the Part No. required. Include Part Description and Drill Size (4 place decimal).

For Collar Only, omit prefix 'A' and add 'C.'

For Insert Only, omit prefix 'A' and add suffix 'I' plus 4 place decimal I.D. size.

Example: UDB-62531-I (.2500)

For Spring Only, add suffix 'S.' Example: UDB-62531-S

UDB - A - 62531 (.2500)



(DRILL) A	.2500	.3125	.3750	.2812	.3438	.4062	.4688	.5312	
A MIN	.0938	.0938	.0938	.1875	.1875	.1875	.1875	.1875	
(SHANK OD) B	3/8	7/16	1/2	7/16	1/2	9/16	5/8	3/4	
C1 MIN FLUSH	C MAX TO 1/2	A-61102	A-61202	A-61302	A-62102	A-62202	A-62302	A-62402	A-62502
1/8	5/8	A-61103	A-61203	A-61303	A-62103	A-62203	A-62303	A-62403	A-62503
1/4	3/4	A-61104	A-61204	A-61304	A-62104	A-62204	A-62304	A-62404	A-62504
3/8	7/8	A-61105	A-61205	A-61305	A-62105	A-62205	A-62305	A-62405	A-62505
1/2	1"	A-61106	A-61206	A-61306	A-62106	A-62206	A-62306	A-62406	A-62506
9/16	1-1/16	A-61107	A-61207	A-61307	A-62107	A-62207	A-62307	A-62407	A-62507
5/8	1-1/8	A-61108	A-61208	A-61308	A-62108	A-62208	A-62308	A-62408	A-62508
11/16	1-3/16	A-61109	A-61209	A-61309	A-62109	A-62209	A-62309	A-62409	A-62509
3/4	1-1/4	A-61110	A-61210	A-61310	A-62110	A-62210	A-62310	A-62410	A-62510
7/8	1-3/8	A-61111	A-61211	A-61311	A-62111	A-62211	A-62311	A-62411	A-62511
15/16	1-7/16	A-61112	A-61212	A-61312	A-62112	A-62212	A-62312	A-62412	A-62512
1"	1-1/2	A-61113	A-61213	A-61313	A-62113	A-62213	A-62313	A-62413	A-62513
1-1/8	1-5/8	A-61114	A-61214	A-61314	A-62114	A-62214	A-62314	A-62414	A-62514
1-1/4	1-3/4	A-61115	A-61215	A-61315	A-62115	A-62215	A-62315	A-62415	A-62515
1-3/8	1-7/8	A-61116	A-61216	A-61316	A-62116	A-62216	A-62316	A-62416	A-62516
1-7/16	1-15/16	A-61117	A-61217	A-61317	A-62117	A-62217	A-62317	A-62417	A-62517
1-1/2	2"	A-61118	A-61218	A-61318	A-62118	A-62218	A-62318	A-62418	A-62518
1-5/8	2-1/8	A-61119	A-61219	A-61319	A-62119	A-62219	A-62319	A-62419	A-62519
1-3/4	2-1/4	A-61120	A-61220	A-61320	A-62120	A-62220	A-62320	A-62420	A-62520
1-7/8	2-3/8	A-61121	A-61221	A-61321	A-62121	A-62221	A-62321	A-62421	A-62521
2"	2-1/2	A-61122	A-61222	A-61322	A-62122	A-62222	A-62322	A-62422	A-62522
2-1/8	2-5/8	A-61123	A-61223	A-61323	A-62123	A-62223	A-62323	A-62423	A-62523
2-1/4	2-3/4	A-61124	A-61224	A-61324	A-62124	A-62224	A-62324	A-62424	A-62524
2-1/2	3"	A-61125	A-61225	A-61325	A-62125	A-62225	A-62325	A-62425	A-62525
2-3/4	3-1/4	A-61126	A-61226	A-61326	A-62126	A-62226	A-62326	A-62426	A-62526
3"	3-1/2	A-61127	A-61227	A-61327	A-62127	A-62227	A-62327	A-62427	A-62527
3-1/4	3-3/4	A-61128	A-61228	A-61328	A-62128	A-62228	A-62328	A-62428	A-62528
3-1/2	4"	A-61129	A-61229	A-61329	A-62129	A-62229	A-62329	A-62429	A-62529
3-3/4	4-1/4	A-61129A	A-61229A	A-61329A	A-62129A	A-62229A	A-62329A	A-62429A	A-62529A
4"	4-1/2	A-61129B	A-61229B	A-61329B	A-62129B	A-62229B	A-62329B	A-62429B	A-62529B
4-1/4	4-3/4	A-61129C	A-61229C	A-61329C	A-62129C	A-62229C	A-62329C	A-62429C	A-62529C
4-1/2	5"	A-61130	A-61230	A-61330	A-62130	A-62230	A-62330	A-62430	A-62530
4-3/4	5-1/4	A-61130A	A-61230A	A-61330A	A-62130A	A-62230A	A-62330A	A-62430A	A-62530A
5"	5-1/2	A-61130B	A-61230B	A-61330B	A-62130B	A-62230B	A-62330B	A-62430B	A-62530B
5-1/4	5-3/4	A-61130C	A-61230C	A-61330C	A-62130C	A-62230C	A-62330C	A-62430C	A-62530C
5-1/2	6"	A-61131	A-61231	A-61331	A-62131	A-62231	A-62331	A-62431	A-62531
C1 MIN	C MAX TELESCOPIC RANGE	COLLAR A-61000 ADD I.D. SIZE TO LINERS				COLLAR A-62000 ADD I.D. SIZE TO LINERS			

LINER I.D.	3/8	7/16	1/2	7/16	1/2	9/16	5/8	3/4
HELICAL NURLOCK LINERS	DOUBLE LOCK METAL	HNL-213212	HNL-214808	HNL-214808	HNL-224808	HNL-225210	HNL-225610	HNL-226410
HELICAL NURLOCK LINERS	SINGLE LOCK METAL	HNL-1-213212	HNL-1-214808	HNL-1-214808	HNL-1-224808	HNL-1-225210	HNL-1-225610	HNL-1-226410
STD NURLOCK LINERS	DOUBLE LOCK FOR METAL	NL-16520		NL-16521	WE RECOMMEND			NL-16522
STD NURLOCK LINERS	DOUBLE LOCK FOR PLASTIC	NLP-375		NLP-500	HNL and HNLP			NLP-750
LOCK SCREW LINERS	FOR METAL	LL-21100	LL-21200	LL-21300				LL-22400
LOCK SCREW LINERS	FOR PLASTIC	NL-21100	NL-21200	NL-21300	NL-22100	NL-22200	NL-22300	NL-22400
LOCK RINGS	UDB-521449	UDB-521450A	UDB-521450A	UDB-521451	UDB-521451	UDB-521451A	UDB-521451	UDB-521452
HELICAL NURLOCK LINERS	DOUBLE LOCK PLASTIC	HNLP-213212	HNLP-214808	HNLP-214808	HNLP-224808	HNLP-225210	HNLP-225610	HNLP-226410
HELICAL NURLOCK LINERS	SINGLE LOCK PLASTIC	HNLP-1-213212	HNLP-1-214808	HNLP-1-214808	HNLP-1-224808	HNLP-1-225210	HNLP-1-225610	HNLP-1-226410
TAPERED NURLOCK CLAMPS	TLC-2	TLC-2	TLC-2	TLC-2	TLC-2	TLC-2	TLC-2	TLC-2
LINER BUSHINGS	19936	19937	19938	19937	19938	19939	19940	19941
LOCK SCREWS	16531	16531	16531	16532	16532	16532	16532	16532

LOCKING ACCESSORIES in this Section



60,000 Series

With Broad I.D. Range

60,000 Series
Telescopic

A-63000 24000 SERIES THD

A-64000 25000 SERIES THD

A-65000 26000 SERIES THD

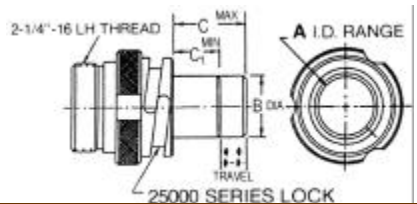
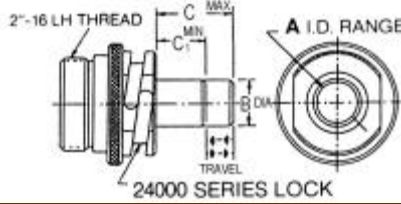
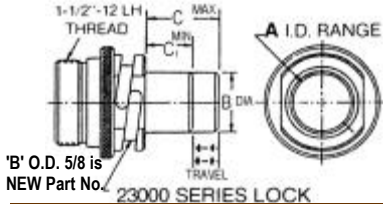

'B' O.D. 5/8 is
NEW Part No.

'B' O.D.s
13/16 and
1-3/8 are
NEW Part
No.s

A-63000 24000 SERIES THD						A-64000 25000 SERIES THD						A-65000 26000 SERIES THD						A MAX	A MIN	B SHANK O.D.			
.4688	.5312	.5938	.6562	.7188	.7500	.4688	.5312	.5937	.6562	.7812	.9062	.9375	1.1250	1.1875	1.032	1.1562	1.2812	1.4688	1.5000			C1 MIN	C2 MAX
2500	2500	2500	2500	2500	2500	.3125	.3125	.3125	.3125	.3125	.3125	.3125	.3125	.3125	.3750	.3750	.3750	.3750	.3750			TO	TO
5/8	3/4	13/16	7/8	1"	1-1/8	5/8	3/4	13/16	7/8	1"	1-1/8	1-1/4	1-3/8	1-1/2	1-1/4	1-3/8	1-1/2	1-3/4	2"				
A-63002	A-63102	A-63202	A-63302	A-63402	A-63502	A-64102	A-64302	A-64202	A-64402	A-64502	A-64602	A-64702	A-64902	A-64802	A-65102	A-65202	A-65302	A-65402	A-65502				
A-63003	A-63103	A-63203	A-63303	A-63403	A-63503	A-64103	A-64303	A-64203	A-64403	A-64503	A-64603	A-64703	A-64903	A-64803	A-65103	A-65203	A-65303	A-65403	A-65503	1/8	5/8		
A-63004	A-63104	A-63204	A-63304	A-63404	A-63504	A-64104	A-64304	A-64204	A-64404	A-64504	A-64604	A-64704	A-64904	A-64804	A-65104	A-65204	A-65304	A-65404	A-65504	1/4	3/4		
A-63005	A-63105	A-63205	A-63305	A-63405	A-63505	A-64105	A-64305	A-64205	A-64405	A-64505	A-64605	A-64705	A-64905	A-64805	A-65105	A-65205	A-65305	A-65405	A-65505	3/8	7/8		
A-63006	A-63106	A-63206	A-63306	A-63406	A-63506	A-64106	A-64306	A-64206	A-64406	A-64506	A-64606	A-64706	A-64906	A-64806	A-65106	A-65206	A-65306	A-65406	A-65506	1/2	1"		
A-63007	A-63107	A-63207	A-63307	A-63407	A-63507	A-64107	A-64307	A-64207	A-64407	A-64507	A-64607	A-64707	A-64907	A-64807	A-65107	A-65207	A-65307	A-65407	A-65507	9/16	1-1/16		
A-63008	A-63108	A-63208	A-63308	A-63408	A-63508	A-64108	A-64308	A-64208	A-64408	A-64508	A-64608	A-64708	A-64908	A-64808	A-65108	A-65208	A-65308	A-65408	A-65508	5/8	1-1/8		
A-63009	A-63109	A-63209	A-63309	A-63409	A-63509	A-64109	A-64309	A-64209	A-64409	A-64509	A-64609	A-64709	A-64909	A-64809	A-65109	A-65209	A-65309	A-65409	A-65509	11/16	1-3/16		
A-63010	A-63110	A-63210	A-63310	A-63410	A-63510	A-64110	A-64310	A-64210	A-64410	A-64510	A-64610	A-64710	A-64910	A-64810	A-65110	A-65210	A-65310	A-65410	A-65510	3/4	1-1/4		
A-63011	A-63111	A-63211	A-63311	A-63411	A-63511	A-64111	A-64311	A-64211	A-64411	A-64511	A-64611	A-64711	A-64911	A-64811	A-65111	A-65211	A-65311	A-65411	A-65511	7/8	1-3/8		
A-63012	A-63112	A-63212	A-63312	A-63412	A-63512	A-64112	A-64312	A-64212	A-64412	A-64512	A-64612	A-64712	A-64912	A-64812	A-65112	A-65212	A-65312	A-65412	A-65512	15/16	1-7/16		
A-63013	A-63113	A-63213	A-63313	A-63413	A-63513	A-64113	A-64313	A-64213	A-64413	A-64513	A-64613	A-64713	A-64913	A-64813	A-65113	A-65213	A-65313	A-65413	A-65513	1"	1-1/2		
A-63014	A-63114	A-63214	A-63314	A-63414	A-63514	A-64114	A-64314	A-64214	A-64414	A-64514	A-64614	A-64714	A-64914	A-64814	A-65114	A-65214	A-65314	A-65414	A-65514	1-1/8	1-5/8		
A-63015	A-63115	A-63215	A-63315	A-63415	A-63515	A-64115	A-64315	A-64215	A-64415	A-64515	A-64615	A-64715	A-64915	A-64815	A-65115	A-65215	A-65315	A-65415	A-65515	1-1/4	1-3/4		
A-63016	A-63116	A-63216	A-63316	A-63416	A-63516	A-64116	A-64316	A-64216	A-64416	A-64516	A-64616	A-64716	A-64916	A-64816	A-65116	A-65216	A-65316	A-65416	A-65516	1-3/8	1-7/8		
A-63017	A-63117	A-63217	A-63317	A-63417	A-63517	A-64117	A-64317	A-64217	A-64417	A-64517	A-64617	A-64717	A-64917	A-64817	A-65117	A-65217	A-65317	A-65417	A-65517	1-7/16	1-15/16		
A-63018	A-63118	A-63218	A-63318	A-63418	A-63518	A-64118	A-64318	A-64218	A-64418	A-64518	A-64618	A-64718	A-64918	A-64818	A-65118	A-65218	A-65318	A-65418	A-65518	1-1/2	2"		
A-63019	A-63119	A-63219	A-63319	A-63419	A-63519	A-64119	A-64319	A-64219	A-64419	A-64519	A-64619	A-64719	A-64919	A-64819	A-65119	A-65219	A-65319	A-65419	A-65519	1-5/8	2-1/8		
A-63020	A-63120	A-63220	A-63320	A-63420	A-63520	A-64120	A-64320	A-64220	A-64420	A-64520	A-64620	A-64720	A-64920	A-64820	A-65120	A-65220	A-65320	A-65420	A-65520	1-3/4	2-1/4		
A-63021	A-63121	A-63221	A-63321	A-63421	A-63521	A-64121	A-64321	A-64221	A-64421	A-64521	A-64621	A-64721	A-64921	A-64821	A-65121	A-65221	A-65321	A-65421	A-65521	1-7/8	2-3/8		
A-63022	A-63122	A-63222	A-63322	A-63422	A-63522	A-64122	A-64322	A-64222	A-64422	A-64522	A-64622	A-64722	A-64922	A-64822	A-65122	A-65222	A-65322	A-65422	A-65522	2"	2-1/2		
A-63023	A-63123	A-63223	A-63323	A-63423	A-63523	A-64123	A-64323	A-64223	A-64423	A-64523	A-64623	A-64723	A-64923	A-64823	A-65123	A-65223	A-65323	A-65423	A-65523	2-1/8	2-5/8		
A-63024	A-63124	A-63224	A-63324	A-63424	A-63524	A-64124	A-64324	A-64224	A-64424	A-64524	A-64624	A-64724	A-64924	A-64824	A-65124	A-65224	A-65324	A-65424	A-65524	2-1/4	2-3/4		
A-63025	A-63125	A-63225	A-63325	A-63425	A-63525	A-64125	A-64325	A-64225	A-64425	A-64525	A-64625	A-64725	A-64925	A-64825	A-65125	A-65225	A-65325	A-65425	A-65525	2-1/2	3"		
A-63026	A-63126	A-63226	A-63326	A-63426	A-63526	A-64126	A-64326	A-64226	A-64426	A-64526	A-64626	A-64726	A-64926	A-64826	A-65126	A-65226	A-65326	A-65426	A-65526	2-3/4	3-1/4		
A-63027	A-63127	A-63227	A-63327	A-63427	A-63527	A-64127	A-64327	A-64227	A-64427	A-64527	A-64627	A-64727	A-64927	A-64827	A-65127	A-65227	A-65327	A-65427	A-65527	3"	3-1/2		
A-63028	A-63128	A-63228	A-63328	A-63428	A-63528	A-64128	A-64328	A-64228	A-64428	A-64528	A-64628	A-64728	A-64928	A-64828	A-65128	A-65228	A-65328	A-65428	A-65528	3-1/4	3-3/4		
A-63029	A-63129	A-63229	A-63329	A-63429	A-63529	A-64129	A-64329	A-64229	A-64429	A-64529	A-64629	A-64729	A-64929	A-64829	A-65129	A-65229	A-65329	A-65429	A-65529	3-1/2	4"		
A-63029A	A-63129A	A-63229A	A-63329A	A-63429A	A-63529A	A-64129A	A-64329A	A-64229A	A-64429A	A-64529A	A-64629A	A-64729A	A-64929A	A-64829A	A-65129A	A-65229A	A-65329A	A-65429A	A-65529A	3-3/4	4-1/4		
A-63029B	A-63129B	A-63229B	A-63329B	A-63429B	A-63529B	A-64129B	A-64329B	A-64229B	A-64429B	A-64529B	A-64629B	A-64729B	A-64929B	A-64829B	A-65129B	A-65229B	A-65329B	A-65429B	A-65529B	4"	4-1/2		
A-63029C	A-63129C	A-63229C	A-63329C	A-63429C	A-63529C	A-64129C	A-64329C	A-64229C	A-64429C	A-64529C	A-64629C	A-64729C	A-64929C	A-64829C	A-65129C	A-65229C	A-65329C	A-65429C	A-65529C	4-1/4	4-3/4		
A-63030	A-63130	A-63230	A-63330	A-63430	A-63530	A-64130	A-64330	A-64230	A-64430	A-64530	A-64630	A-64730	A-64930	A-64830	A-65130	A-65230	A-65330	A-65430	A-65530	4-1/2	5"		
A-63030A	A-63130A	A-63230A	A-63330A	A-63430A	A-63530A	A-64130A	A-64330A	A-64230A	A-64430A	A-64530A	A-64630A	A-64730A	A-64930A	A-64830A	A-65130A	A-65230A	A-65330A	A-65430A	A-65530A	4-3/4	5-1/4		
A-63030B	A-63130B	A-63230B	A-63330B	A-63430B	A-63530B	A-64130B	A-64330B	A-64230B	A-64430B	A-64530B	A-64630B	A-64730B	A-64930B	A-64830B	A-65130B	A-65230B	A-65330B	A-65430B	A-65530B	5"	5-1/2		
A-63030C	A-63130C	A-63230C	A-63330C	A-63430C	A-63530C	A-64130C	A-64330C	A-64230C	A-64430C	A-64530C	A-64630C	A-64730C	A-64930C	A-64830C	A-65130C	A-65230C	A-65330C	A-65430C	A-65530C	5-1/4	5-3/4		
A-63031	A-63131	A-63231	A-63331	A-63431	A-63531	A-64131	A-64331	A-64231	A-64431	A-64531	A-64631	A-64731	A-64931	A-64831	A-65131	A-65231	A-65331	A-65431	A-65531	5-1/2	6"		

COLLAR A-63000 ADD I.D. SIZE TO LINERS

COLLAR A-64000 ADD I.D. SIZE TO LINERS

COLLAR A-65000 ADD I.D. SIZE TO LINERS

COLLAR A-63000 ADD I.D. SIZE TO LINERS						COLLAR A-64000 ADD I.D. SIZE TO LINERS						COLLAR A-65000 ADD I.D. SIZE TO LINERS						LINER I. D.					
5/8	3/4	13/16	7/8	1"	1-1/8	5/8	3/4	13/16	7/8	1"	1-1/8	1-1/4	1-3/8	1-1/2	1-1/4	1-3/8	1-1/2	1-3/4	2"			C1 MIN	C2 MAX
HNL-235610	HNL-236410	HNL-236410	HNL-238016	HNL-239616	HNL-239624	HNL-245616	HNL-246416	HNL-246416	HNL-248016	HNL-248016	HNL-248816	HNL-249616	HNL-241121	HNL-241281	HNL-25100	HNL-25200	HNL-25300	HNL-25400	HNL-25500	HELICAL NURLOCK LINERS	DOUBLE LOCK METAL		
HNL-1-235610	HNL-1-236410	HNL-1-236410	HNL-1-238016	HNL-1-239616	HNL-1-239624	HNL-1-245616	HNL-1-246416	HNL-1-246416	HNL-1-248016	HNL-1-248016	HNL-1-248816	HNL-1-249616	HNL-1-241121	HNL-1-241281	WE RECOMMEND						HELICAL NURLOCK LINERS	SINGLE LOCK METAL	
			NL-16523		NL-16524					NL-16525				NL-16526	HNL and HNL						NL-16533	DOUBLE LOCK FOR METAL	
			NLP-16523		NLP-16524					NLP-16525				NLP-16526							NLP-16533	DOUBLE LOCK PLASTIC	
	LL-23100	LL-23200	LL-23300	LL-23400	LL-23500	LL-24100	LL-24300	LL-24300	LL-24400	LL-24500	LL-24600	LL-24700		LL-24800	LL-25100	LL-25200	LL-25300	LL-25400	LL-25500	LOCK SCREW LINERS	FOR METAL		
	NL-23100	NL-23200	NL-23300	NL-23400	NL-23500	NL-24100	NL-24300	NL-24300	NL-24400	NL-24500	NL-24600	NL-24700		NL-24800	LLP-25100	LLP-25200	LLP-25300	LLP-25400	LLP-25500</				