























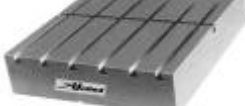

UCC-TWP PLAIN No Holes TYPE VII  PAGE E8	UCC-TWQ QUALIFIED HOLES  PAGE E8	UCC-TWTS T-SLOTS  PAGE E8	UCC-TWT TAPPED HOLES  PAGE E8	UCC-TWS ANY SPECIAL COMBINATION OR CONFIGURATION OF TYPE VII WINDOWS WITH BASE
UCC-TTFP VIII  PAGE E8	UCC-TTFQ  PAGE E8	UCC-TTFTS  PAGE E8	UCC-TTFT  PAGE E8	UCC-TTFS ANY SPECIAL COMBINATION OR CONFIGURATION OF TYPE VIII T-FIXTURES WITH BASE
UCC-TAPP IX  PAGE E9	UCC-TAPQ  PAGE E9	UCC-TAPT  PAGE E9	UCC-TAPT  PAGE E9	UCC-TAPS ANY SPECIAL COMBINATION OR CONFIGURATION OF TYPE IX ANGLE PLATES WITH BASE
UCC-TRP X  PAGE E10	UCC-TRQ  PAGE E10	UCC-TRTS  PAGE E10	UCC-TRT  PAGE E10	UCC-TRS ANY SPECIAL COMBINATION OR CONFIGURATION OF TYPE X ROUND RISERS NO BASE
UCC-TSP XI  PAGE E11	UCC-TSQ  PAGE E11	UCC-TSTS  PAGE E11	UCC-TST  PAGE E11	UCC-TSS ANY SPECIAL COMBINATION OR CONFIGURATION OF TYPE XI SQUARE RISERS NO BASE
UCC-TSPP XII  PAGE E12	UCC-TSPQ  PAGE E12	UCC-TSPTS  PAGE E12	UCC-TSPT  PAGE E12	UCC-TSPS ANY SPECIAL COMBINATION OR CONFIGURATION OF TYPE XII SUB-PLATES NO BASE

UNITED provides Tombstones® and UniFixtures in Cubes, Silos, Columns and whatever design you require. Bases are milled to your machining center with hold down and location holes that fit. Approval drawings are always provided for your assurance of fit. We maximize travel and minimize lost center space. Single piece construction from superior quality Meehanite, cast iron or aluminum. UNITED's cost-effective low volume UniFixtures and high production tools lower your costs.

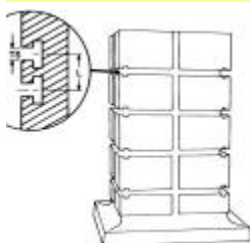

T-SLOTS

UNITED PREFIX NO. UCC-TxTS	TOLERANCES	
	STANDARD	LOOSE
TS T-SLOT SIZE	±.0008	±.010
L LOCATION	±.0015	±.010

TAPPED HOLES

UNITED PREFIX NO. UCC-TxT	TOLERANCES	
	STANDARD	LOOSE
H ₁ - H ₂ HOLE to Adjacent Hole	±.005	±.005

TOLERANCES

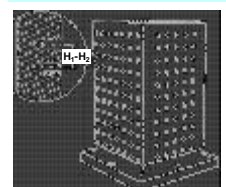

UNITED POLICY

To provide you cost-effective UniFixtures pricing with superior quality, service and value.

Tombstone® With Base Type I

Tombstone® Tooling Blocks With Base FOUR FACES TO INCREASE YOUR INVESTMENT RETURN

TYPE I

Refer to Dimensions for each Style of TYPE I on Next Page.

UCC-TBQ

QUALIFIED HOLES
BORED and TAPPED
Tombstone with Base

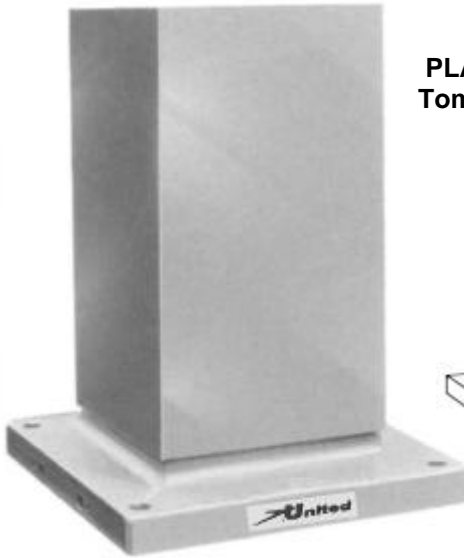

UCC-TBP
PLAIN — NO HOLES
Tombstone with Base

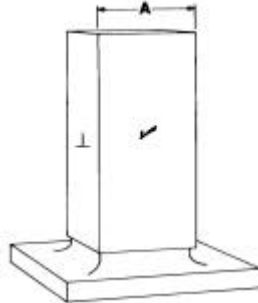

NO HOLES DO IT YOURSELF! CUSTOMIZE TO FIT YOUR NEEDS.

UNITED PREFIX NO. UCC-TBP	A SIZE	TOLERANCES	
		STANDARD	LOOSE
		±.002	+.010 -.000 OR OVERSIZE
✓	FINISH	63 RMS	125 RMS
⊥	PERPENDICULAR-	.001/FT.	.002/FT.

Tolerances for overall size, finish and perpendicularity are shown for Style UCC-TBP only.

The same tolerances apply to all styles.

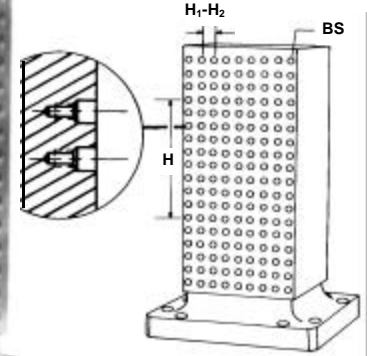
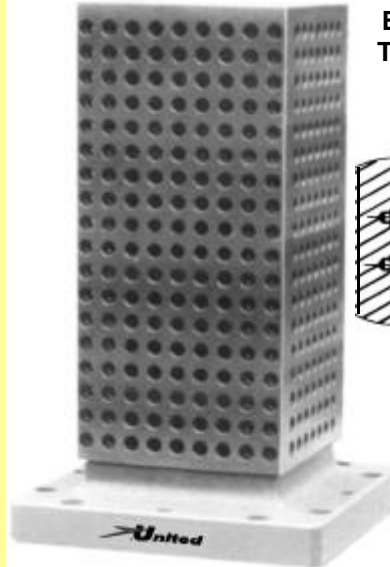

SELF-LUBRICATING

UNITED PREFIX NO. UCC-TBQ	H ₁ - H ₂ HOLE to Adjacent Hole	TOLERANCES	
		STANDARD	LOOSE
		±.0005	HOLES Available in Conventional Tolerances Only
	H HOLE to Any Hole on Grid	±.0015	
	BS BORE Size Location from Datum	±.0005 ±.002	

BORED AT THE TOP AND TAPPED AT THE BOTTOM ON 1" OR 2" GRID.

5/8 BORE HAS 1/2 - 13 TAP.
3/4 BORE HAS 5/8 TO TAP.
7/8 BORE HAS 3/4 TO TAP.

ACCURATE LOCATING

UCC-TBTS
T-SLOTS NO HOLES
Tombstone with Base

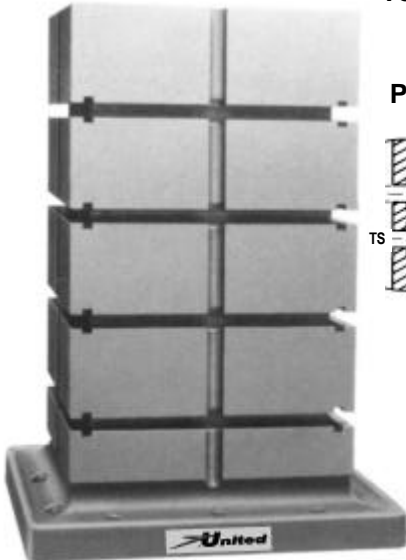

PRECISION DESIGNED

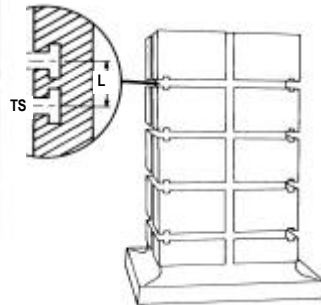

DIMENSIONAL STABILITY WITH HIGH COMPRESSION STRENGTH

UNITED PREFIX NO. UCC-TBTS	TS T-SLOT SIZE	TOLERANCES	
		STANDARD	LOOSE
		±.0008	±.010
L	LOCATION	±.0015	±.010

Refer to Diagram of your required style of Type I and see Dimensions on Next Page.

WEAR RESISTANT

UCC-TBT
TAPPED HOLES
Tombstone with Base

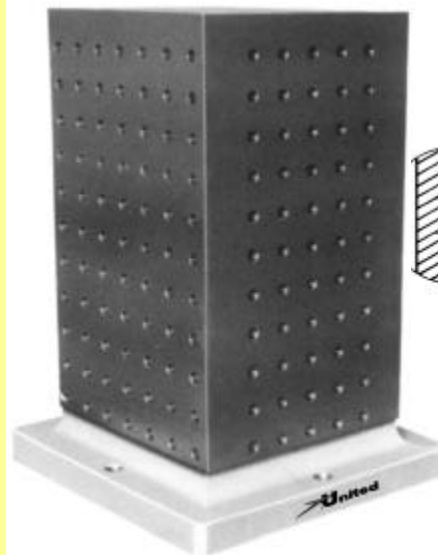

ANY SIZE 2" GRID SPACING

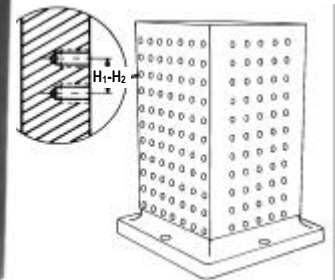

VIBRATION DAMPING CAPACITY

UNITED PREFIX NO. UCC-TBT	H ₁ - H ₂ HOLE to Adjacent Hole	TOLERANCES	
		STANDARD	LOOSE
		±.005	±.005

AND UCC-TBS SPECIAL IS ANY COMBO OF THESE

Sizes Available Tombstone® Tooling Blocks

For Available Part Numbers, Add Prefix

SELECT YOUR TOMBSTONE® HERE!

Use the dimensions of the various surfaces shown in the Table, and refer to the diagram on the right.

Part Numbers in the left columns require **UNITED S PREFIX** when you select your required size. Other sizes available on request.

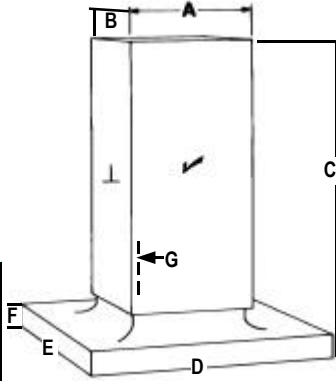

FINISH FACE DIMENSIONS

UNITED PREFIX	DESCRIPTION
UCC-TBP	Plain
UCC-TBQ	Qualified Bored Tapped
UCC-TBTS	T-Slots
UCC-TBT	Tapped
UCC-TBS	Any Combo of Above

ADD UNITED S PREFIX TO PART NO.	FRONT FACE A	SIDE FACE B	FINISH HEIGHT C	FRONT BASE D	SIDE BASE E	HEIGHT FLANGE F	THICKNESS WALL
4825-16	4	8.25	25	16	16	1.75	SOLID
4188-8x18	3.75	18	8.375	7.5	17.5	1.5	SOLID
558-10	5.25	5.25	8.75	10	10	0.75	0.75
5511-10	5.25	5.25	11.625	10	10	1	SOLID
5514-12	4.75	4.75	13.75	12	12	0.875	0.875
5517-9	5	5	17.75	9 DIA	9 DIA	1	1
5525-9	5	5	25.25	9 DIA	9 DIA	1	1
6612-12	6	6	12	12	12	1.5	1.25
61222-14x16	6	12	22	16	16	2	SOLID
61622-16	6	16	22	16	16	1.5	1.5
7710-10	7.625	7.625	10.75	10	10	0.75	0.75
8814-13	8	8	14	13	13	0.75	0.75
8815-12	8	8	15	12	12	1.375	1.25
8822-18	8	8	22	18	18	1.75	1.75
8822-18-3	8	8	22	18	18	1.75	2
8829-18	8	8	29	18	18	1.625	1.75
81024-14	8	10	24	14	18	1.5	1.75
81024-18	8	10	24	18	18	1.5	1.75
81224-16	8	12	24	16	16	1.75	2
81426-18	8	14	26	18	18	1.75	2
81520-15	8	15.75	20	15	15	1.75	1.375
81629-18	8	16	29	18	18	1.625	1.75
81824-18	8	18	24	18	18	1.75	2
82037-24	8	20	37	24	24	2	1.5
9922-13	9	9	22	13	13	1.75	1.75
9922-16	9	9	22	16	16	1.75	1.75
9922-18	9	9	22	18	18	1.75	1.75
91522-16X21	9	15	22	16	21	1.75	2
91530-18	9	15	30	18	18	1.75	1.75
92010-14x20	9	20	10	14	20	1.75	2
92020-14x20	9	20	20	14	20	1.75	2
92032-17x24	9	20	32	17	24	2.25	2
101018-16	10	10	18	16	16	1	1.75

ORDERING EXAMPLE WITH PREFIX AND TYPE: UCC-TBQ-101018-16

ADD UNITED S PREFIX TO PART NO.	FRONT FACE A	SIDE FACE B	FINISH HEIGHT C	FRONT BASE D	SIDE BASE E	HEIGHT FLANGE F	THICKNESS WALL G
101024-16	10	10	24	16	16	1.75	1.75
101024-18	10	10	24	18	18	1.75	1.75
101024T-18	10	10	24	18.25	18.25	1.5	1.25
101024-25	10	10	24	25	25	1.75	1.75
101025-18	10	10	25.25	18	18	2	1.75
101030-18	10	10	30	18	18	1.75	1.75
102424-32	10	23.25	24.5	32	32	1.5	1.5
102534-25	10	25	34	25	25	2	2
102633-31	10	26	33	31	31	1.5	1.25
103036-16x30	10	30	36	16	30	2	2
103036-22x30	10	30	36	22	30	2	2
121212-16	12	12	12	16	16	0.75	1
121216-14	12	12	16	14	14	1.5	1.5
121224-16	12	12	24	16	16	1.75	2
121224-18	12	12	24	18	18	1.75	2
121229-20	12	12	29.75	20	20	1.75	1.625
121229-25	12	12	29.75	25	25	1.75	1.625
122031-20	12	20	31.5	20	20	1.5	1.5
122430-24	12	24	30	24	24	1.75	2
122436-24	12	24	36	24	24	1.75	2
131322-18	13.25	13.25	22.5	18	18	1.75	2
141424-16	14	14	24	16	16	1.75	2
141426-18	14	14	26	18	18	1.75	2
141426-25	14	14	26	25	25	1.75	2
141632-25	14	16	32	25	25	2	2
141824-18	14	18	24	18	18.25	2	2
151519-18	15	15	19	18	18	1.75	1.75
153052-30	15	30	52	29.5	30.25	2	2
161616-18	16	16	16	18	18	1.25	2
161620-20	16	16	20	20	20	1.75	2
161633-25	16	16	33	25	25	2	2
161832-25	16	18	32	25	25	2	2
162230-20x25	16	22	30	20	25	2	2
163238-24x32	16	32	38	24	32	2	2
163247-24x32	16	32	47	34	32	2	2
181820-24	18	18	20	24	24	1.75	2
181830T-22	18	18	30	22	22	1.75	1.75
181830S-22	18	18	30	22	22	1.625	1.25
181830-28	18	18	30	28	28	1.75	1.75
181836-22	18	18	35.875	22	22	2	2
181824-25	18.5	18.5	24.5	25	25	1.75	2
202030-30	20	20	30	30	30	2	2
202032-20x27	20	20	31.5	20	27	2	2
232325-32	23	23	25.5	32	32	1.5	1.5
242436-28	24	24	35.875	28	28	2.25	2
243235-32	24	32	35	31	32	2	2
245262-52	24	52	62	49	52	4	3.625
303048-40	30	30	47.875	40	40	2.375	2
363660-48	36	36	60	48	48	2.75	2